

Data Sheet



Article number: 20531ND18RT

Description: E+G Magnet GN 53.1-ND-18-RT, Plastic housing
Neodym, iron, boron, 80°C

Measures

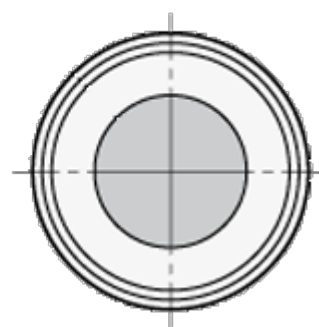
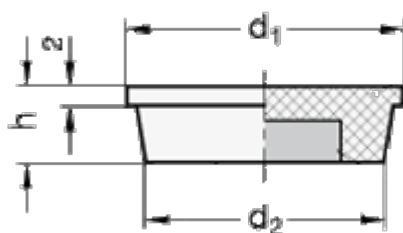

d1	= 18
d2	= 14
h	= 8.0
Holding force N	= 10